

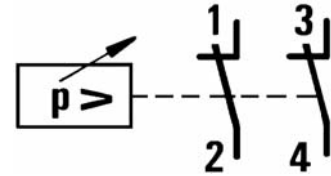

U imp 6 kV Ie 16 A Iq 3 kA

Max. zul. Motorleistung / Max. Motor Performance / Max.
 Potencia admisible del Motor / Puissance max. du Moteur /
 Pot. max. ammissibile dei motori



	EN 60947 – 4 - 1	UL - CSA	
50.. ..60 Hz	1~	1~	3~
120 V AC3	1,1 kW	1,5 HP	3 HP
230 – 240 V AC3	2,2 kW	3,0 HP	5 HP

DRAUFSICHT / TOP VIEW / VISTA SUPERIOR / VUE SUPERIEURE / VISTA DALL'ALTO
SCHALTBILD / WIRING DIAGRAM / ESQUEMA DE CONEXION /
SCHEMA DE RACCORDAMENT / SCHEMA ELETTRICO

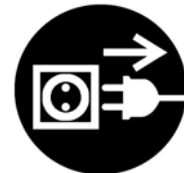
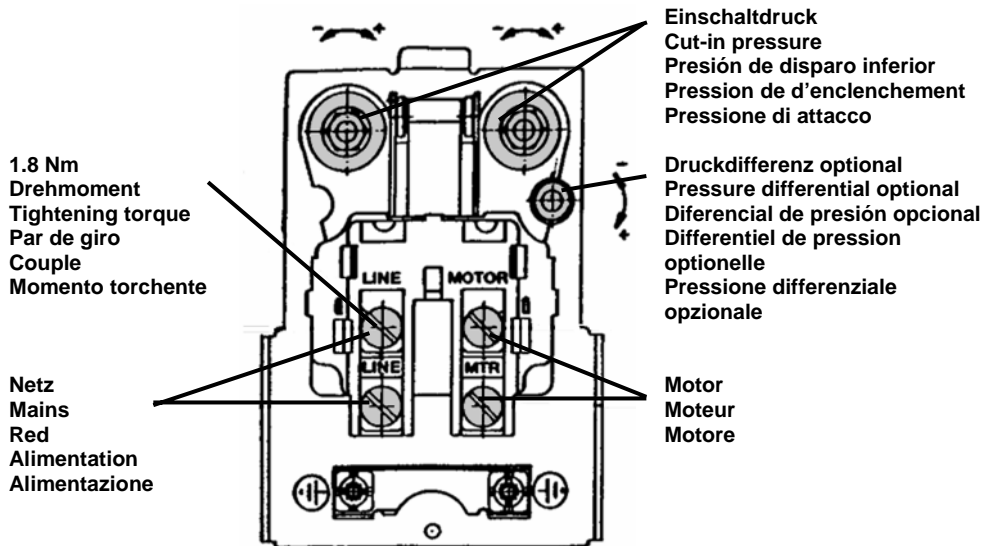

DRUCKDIAGRAMME / PRESSURE DIAGRAMS / DIAGRAMAS DE REGULACION /
DIAGRAMMES DE REGLAGE / DIAGRAMMI TARATURE

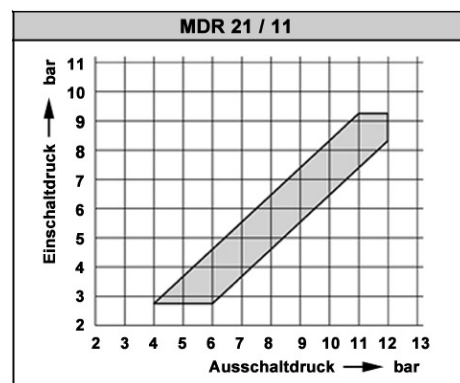
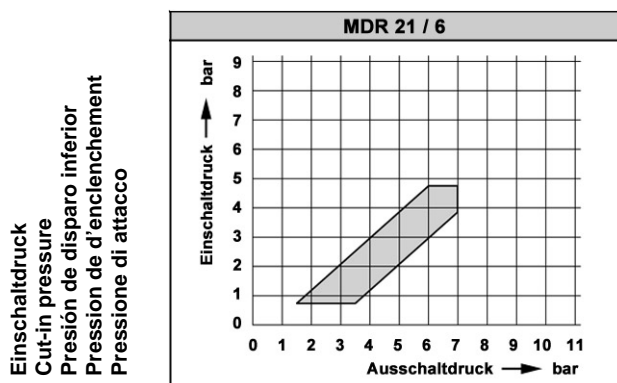

Ausschaltdruck po (bar)
 Cut-out pressure
 Presión de disparo superior
 Pression déclenchement
 Pressione di distacco

Einschaltdruck
Cut-in pressure
Presión de disparo inferior
Pression de d'enclenchement
Pressione di attacco

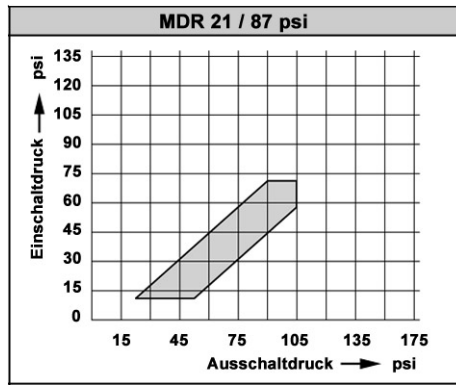

Ausschaltdruck po (psi)
Cut-out pressure
Presión de disparo superior
Pression déclenchement
Pressione di distacco

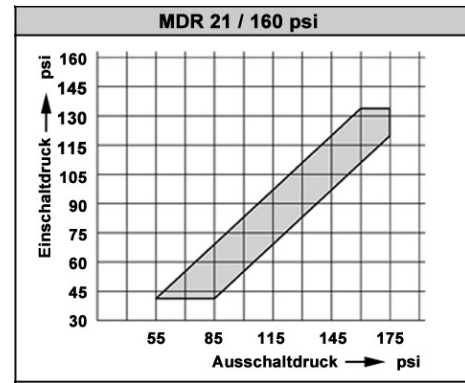

1bar = 14,5 psi;
10 psi = ca. 0,7 bar

Einbau und Anschluß nur durch Fachkraft; nach Anbringung von Zubehör Funktionsüberprüfung durch Elektrofachkraft erforderlich

Installation and assembly of electrical equipment shall be carried out by qualified personnel only
Instalación y ensamblaje de equipos eléctricos deberán ser efectuados solamente por personal cualificado

L'installation et raccordement des appareils doit être effectué par du personnel qualifié

L'installazione e l'assemblaggio delle parti elettriche vanno eseguite esclusivamente da personale qualificato

APPROBATIONEN / APPROVALS / APROBACIONES / APPROBATIONS / APPROVAZIONI



38 D1 LISTED
IND.CONT.EQ

Kurzschlußeinrichtung / Short-circuit protection / Protección contra corto circuito
Protection contre court-circuit/ Protezione contro corto circuito

Type Tipo	Koordination Type " 1 " Co-ordination Type " 1 " Coordinación Tipo " 1 " Coordination Type " 1 " Coordinamento Tipo " 1 "	Koordination Type " 2 " Co-ordination Type " 2 " Coordinación Tipo " 2 " Coordination Type " 2 " Coordinamento Tipo " 2 "
Sicherung gL Fuse (slow) Fusible (retardado) Fusible (retardé) Fusibile (ritardato)	63 A	63 A

IP 44 / IP 41

Einbaulage berücksichtigen / Mounting position must be observed / Respetar posición de montaje
Observer position de montage / Rispettare posizione montaggio

